

## Single Bossed Clamps

Two piece single bossed clamp

Material specifications	
<b>Material</b>	DD11 or equivalent steel
<b>Coatings</b>	Galvanized, Dacrotized, Zinc Magnesium*



### Applications

- Installation of Fire Fighting & Process Pipes
- Suitable for installation of steel pipes

### Features & Benefits

- Solid connection boss, welded all round
- Two locking screws offers enhanced flexibility in accomdating higher variation of pipe diameters
- Dual nut allows multiple threaded attachments
- Reinforced rib design provides enhanced strength

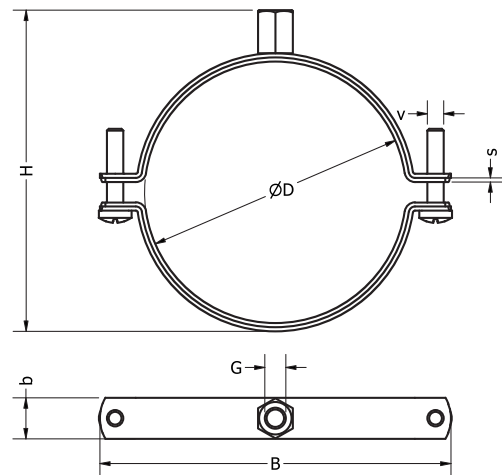

### Select Variant

Article No.		Product Description	Clamping Range (D) (mm)	Pipe Size		G	B	H	bxs	V	Max. Reco. Static Load (Frec) (N)	Pack Size (Nos)
Galvanized (vz)	Dacrotized (fvz)			(inch)	(mm)							
614500	614501	FX SRS Regular w/o lining, M10/M12, 3/4", (26-30)	26-30	3/4"	-	M10/M12	64	60	20x2.0	M6	1900	100
614506	614507	FX SRS Regular w/o lining, M10/M12, 1", (31-37)	31-37	1"	-	M10/M12	71	66	20x2.0	M6	1900	100
614512	614513	FX SRS Regular w/o lining, M10/M12, 40 mm, (38-42)	38-42	-	40	M10/M12	75	70	20x2.0	M6	1900	100
614518	614519	FX SRS Regular w/o lining, M10/M12, 1 1/4", (43-47)	43-47	1 1/4"	-	M10/M12	81	76	20x2.0	M6	1900	50
614524	614525	FX SRS Regular w/o lining, M10/M12, 1 1/2", (47-52)	47-52	1 1/2"	-	M10/M12	87	81	20x2.0	M6	1900	50
614530	614531	FX SRS Regular w/o lining, M10/M12, 57 mm, (53-57)	53-57	-	57	M10/M12	91	86	20x2.0	M6	1900	50
614536	614537	FX SRS Regular w/o lining, M10/M12, 2", (58-63)	58-63	2"	-	M10/M12	100	94	20x2.0	M6	1900	50
614542	614543	FX SRS Regular w/o lining, M10/M12, 70 mm, (64-71)	64-71	-	70	M10/M12	105	99	20x2.0	M6	1900	50
614548	614549	FX SRS Regular w/o lining, M10/M12, 2 1/2", (72-78)	72-78	2 1/2"	-	M10/M12	120	108	25x2.5	M8	1900	50
614554	614555	FX SRS Regular w/o lining, M10/M12, 83 mm, (79-85)	79-85	-	83	M10/M12	126	114	25x2.5	M8	4400	50
614560	614561	FX SRS Regular w/o lining, M10/M12, 3", (85-90)	85-90	3"	-	M10/M12	131	119	25x2.5	M8	4400	50
614566	614567	FX SRS Regular w/o lining, M10/M12, 98 mm, (94-99)	94-99	-	98	M10/M12	142	129	25x2.5	M8	4400	50
614572	614573	FX SRS Regular w/o lining, M10/M12, 102 mm, (99-104)	99-104	-	102	M10/M12	146	133	25x2.5	M8	4400	25
614578	614579	FX SRS Regular w/o lining, M10/M12, 4", (108-115)	108-115	4"	-	M10/M12	157	144	25x2.5	M8	4400	25
614584	614585	FX SRS Regular w/o lining, M10/M12, 122 mm, (118-122)	118-123	-	122	M10/M12	166	153	25x2.5	M8	4400	25
614590	614591	FX SRS Regular w/o lining, M10/M12, 125 mm, (125-130)	125-130	-	125	M10/M12	172	159	25x2.5	M8	4400	25
614596	614597	FX SRS Regular w/o lining, M10/M12, 5", (133-140)	133-140	5"	-	M10/M12	182	169	25x2.5	M8	4400	25
614602	614603	FX SRS Regular w/o lining, M10/M12, 147 mm, (142-148)	142-148	-	147	M10/M12	191	178	25x2.5	M8	4400	25
614608	614609	FX SRS Regular w/o lining, M10/M12, 152 mm, (148-153)	148-153	-	152	M10/M12	196	183	25x2.5	M8	4400	25
614614	614615	FX SRS Regular w/o lining, M10/M12, 160 mm, (154-160)	154-160	-	160	M10/M12	202	189	25x2.5	M8	4400	25
614620	614621	FX SRS Regular w/o lining, M10/M12, 6", (160-169)	160-169	6"	-	M10/M12	210	197	25x2.5	M8	4400	25
614626	614627	FX SRS Regular w/o lining, M10/M12, 170 mm, (170-175)	170-175	-	170	M10/M12	218	205	25x2.5	M8	4400	25
614632	614633	FX SRS Regular w/o lining, M10/M12, 180 mm, (175-180)	175-180	-	180	M10/M12	223	210	25x2.5	M8	5000	25
614638	614639	FX SRS Regular w/o lining, M10/M12, 190 mm, (187-194)	187-194	-	190	M10/M12	235	223	25x2.5	M8	5000	25
614644	614645	FX SRS Regular w/o lining, M10/M12, 210 mm, (206-214)	206-214	-	210	M10/M12	256	243	25x2.5	M8	5000	25
614650	614651	FX SRS Regular w/o lining, M10/M12, 223 mm, (218-226)	218-226	-	223	M10/M12	-	-	40x3.0	M10	5300	10
614656	614657	FX SRS Regular w/o lining, M10/M12, 234 mm, (227-235)	227-235	-	234	M10/M12	-	-	40x3.0	M10	5300	10
614662	614663	FX SRS Regular w/o lining, M10/M12, 241 mm, (235-244)	235-244	-	241	M10/M12	-	-	40x3.0	M10	5300	10

\*Available on request